

Article number: 03442035

Description: Fluro Rod end GE 35EC-NIRO

Measures

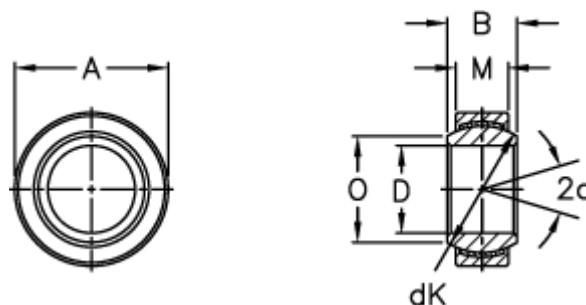

A	= 55 0 -0,013	Tilt angle = 6
B	= 25	Weight = 220
D	= 35 0 -0,012	
dK	= 47	
Dynamic load C (kN)	= 153	
M	= 20	
O	= 39.8	
Static load C0 (kN)	= 298	